

**Material Specifications**

Left Connector: C1016  
 Right Connector: C1003  
 Cable: RG55

**NOTES:**

1. XX EQUALS LENGTH IN INCHES

 <b>Federal Custom Cable</b> www.FCCable.com  1891 Alton Parkway, Irvine, CA 92606 Phone: (949) 851-3114   Fax: (949) 852-8136 Sales@FCCable.com	<b>CAGE CODE</b> 1UKX3	<b>Part Number:</b> CA1018-XX	<b>Description:</b> BNC MALE TO BNC FEMALE COAX CABLE ASSEMBLY WITH RG55 FLEXIBLE CABLE
	<b>Dimensions</b> Millimeters   Inches		
	<b>Scale:</b> N/A	<b>NOTES:</b> 1. DIMENSIONS ARE IN MILLIMETERS   INCHES 2. UNLESS OTHERWISE SPECIFIED ALL DIMENSIONS ARE NOMINAL 3. SPECIFICATIONS ARE SUBJECT TO CHANGE WITHOUT NOTICE	THIS DRAWING CONTAINS PROPRIETART INFORMATION THAT BELONGS TO FEDERAL CUSTOM CABLE, LLC. ANY UNAUTHORIZED USE OF THIS DRAWING IS PROHIBITED WITHOUT WRITTEN PERMISSION FROM FEDERAL CUSTOM CABLE. ALL RIGHTS RESERVED. ©2020 COPYRIGHT FEDERAL CUSTOM CABLE, LLC.
	<b>Revision:</b>		

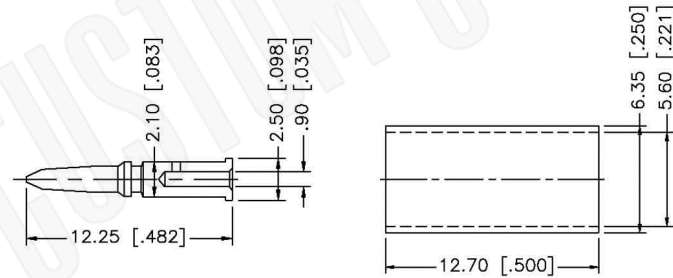
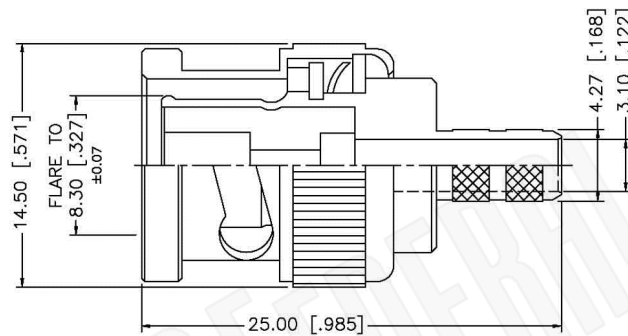
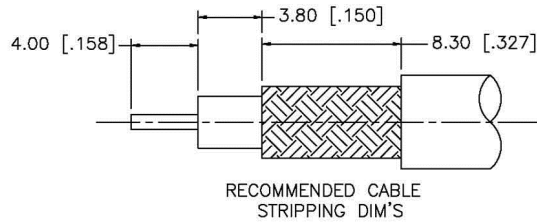

NOTE:

1. CRIMPED FERRULE  
HEX CRIMP SIZE .213"
2. CRIMPED CONTACT PIN  
HEX CRIMP SIZE .068"

**Material Specifications**

Cable(s): RG55,142,223,400  
 Body: Brass  
 Finish: Nickel  
 Insulation: Teflon  
 Impedence: 50 Ohms



**Federal Custom Cable**  
[www.FCCable.com](http://www.FCCable.com)

**CAGE CODE**  
1UKX3

**Part Number:**

**Description:**

**C1016**

**BNC MALE CONNECTOR CRIMP FOR RG55, RG142, RG223, RG400 CABLES**

1891 Alton Parkway, Irvine, CA 92606  
 Phone: (949) 851-3114 | Fax: (949) 852-8136  
[Sales@FCCable.com](mailto:Sales@FCCable.com)

**Dimensions**  
Millimeters | Inches

**Scale:** N/A

**Revision:**

**NOTES:**  
 1. DIMENSIONS ARE IN MILLIMETERS | INCHES  
 2. UNLESS OTHERWISE SPECIFIED ALL DIMENSIONS ARE NOMINAL  
 3. SPECIFICATIONS ARE SUBJECT TO CHANGE WITHOUT NOTICE

THIS DRAWING CONTAINS PROPRIETARY INFORMATION THAT BELONGS TO FEDERAL CUSTOM CABLE, LLC. ANY UNAUTHORIZED USE OF THIS DRAWING IS PROHIBITED WITHOUT WRITTEN PERMISSION FROM FEDERAL CUSTOM CABLE.  
 ALL RIGHTS RESERVED. ©2016 COPYRIGHT FEDERAL CUSTOM CABLE, LLC.

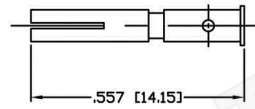
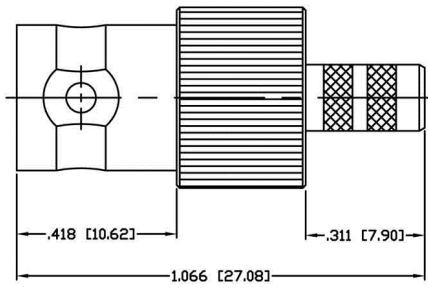

RECOMMENDED CRIMP DIE: .068"

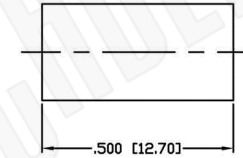

RECOMMENDED CRIMP DIE: .213"

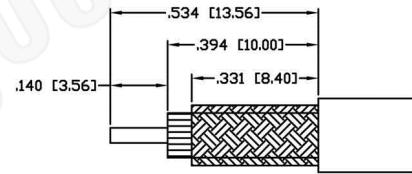

RECOMMENDED STRIPPING DIMENSIONS

### Material Specifications

Cable(s): RG55-142-223-400  
 Body: Brass  
 Finish: Nickel  
 Insulation: Teflon  
 Impedence: 50 Ohms



**Federal Custom Cable**  
[www.FCCable.com](http://www.FCCable.com)

**CAGE CODE**  
 1UKX3

**Part Number:**

**Description:**

**C1003**

**BNC FEMALE CONNECTOR CRIMP FOR RG55,  
 RG142, RG223, RG400 CABLES**

**Dimensions**  
 Millimeters | Inches

**Scale:** N/A

**Revision:**

**NOTES:**  
 1. DIMENSIONS ARE IN MILLIMETERS | INCHES  
 2. UNLESS OTHERWISE SPECIFIED ALL DIMENSIONS ARE NOMINAL  
 3. SPECIFICATIONS ARE SUBJECT TO CHANGE WITHOUT NOTICE

THIS DRAWING CONTAINS PROPRIETARY INFORMATION THAT BELONGS TO FEDERAL CUSTOM CABLE, LLC. ANY UNAUTHORIZED USE OF THIS DRAWING IS PROHIBITED WITHOUT WRITTEN PERMISSION FROM FEDERAL CUSTOM CABLE. ALL RIGHTS RESERVED. ©2016 COPYRIGHT FEDERAL CUSTOM CABLE, LLC.

1891 Alton Parkway, Irvine, CA 92606  
 Phone: (949) 851-3114 | Fax: (949) 852-8136

[Sales@FCCable.com](mailto:Sales@FCCable.com)

# RG55B/U

## 53-Ohm Flexible Coax Cable; 0.545" Diameter, Double Shield, Black PE Jacket

Picture is  
not available  
at this time

PART NUMBER:	<b>RG55B/U</b>
CATAGORY:	FLEXIBLE
DESCRIPTION:	CABLE
IMPEDANCE:	50 OHMS
DIELECTRIC:	POLYETHYLENE
OUTSIDE DIAMETER:	0.116"
NOMINAL OUTSIDE DIAMETER:	0.212"

### MECHANICAL CHARACTERISTICS:

DESCRIPTION ETL/UL/CSA RATING:	RG55B/U MIL-TYPE COMMERCIAL
OVER-BRAID:	N/A
INNER CONDUCTOR:	0.032 DIAMETER SILVER PLATE COPPER, 20 AWG, 8.97 OHM/1000FT NOMINAL DIRECT CURRENT RESISTANCE
OUTER CONDUCTOR & TYPE OF SHIELD:	1ST 95% TINNED COPPER, 2ND 98% TINNED COPPER, 3.1 OHM/1000FT
JACKET MATERIAL:	TYPE II A, NON-CONTAINING, NON-MIGRATING VINYL BLACK

### ELECTRICAL CHARACTERISTICS:

NOMINAL CAPACITANCE (PICO FARAD/FT):	31.0
VELOCITY OF PROPAGATION:	66%
MAXIMUM OPERATING FREQUENCY (GHz):	N/A
MAXIMUM OPERATING RANGE (C):	N/A
MAXIMUM ATTENUATION:	dB (MHz/100ft)
A. 1 MHz:	1.4
B. 50 MHz:	3.2
C. 100 MHz:	4.5
D. 200 MHz:	6.5
E. 400 MHz:	12.8
F. 1000 MHz:	21.0
APPROX WT/1000FT:	45 LBS