

Material Specifications

Left Connector: C1016
 Right Connector: C1003
 Cable: RG223

NOTES:

1. XX EQUALS LENGTH IN INCHES
2. LF DESIGNATES LEAD FREE SOLDER

FCC Federal Custom Cable
 www.FCCable.com
 1891 Alton Parkway, Irvine, CA 92606
 Phone: (949) 851-3114 | Fax: (949) 852-8136
 Sales@FCCable.com

CAGE CODE 1UKX3	Part Number: CA1028LF-XX	Description: BNC MALE TO BNC FEMALE COAX CABLE ASSEMBLY WITH RG223 FLEXIBLE CABLE ROHS LEAD FREE
Scale: N/A	NOTES: 1. DIMENSIONS ARE IN MILLIMETERS INCHES 2. UNLESS OTHERWISE SPECIFIED ALL DIMENSIONS ARE NOMINAL 3. SPECIFICATIONS ARE SUBJECT TO CHANGE WITHOUT NOTICE	THIS DRAWING CONTAINS PROPRIETARY INFORMATION THAT BELONGS TO FEDERAL CUSTOM CABLE, LLC. ANY UNAUTHORIZED USE OF THIS DRAWING IS PROHIBITED WITHOUT WRITTEN PERMISSION FROM FEDERAL CUSTOM CABLE. ALL RIGHTS RESERVED. ©2016 COPYRIGHT FEDERAL CUSTOM CABLE, LLC.
Revision:		

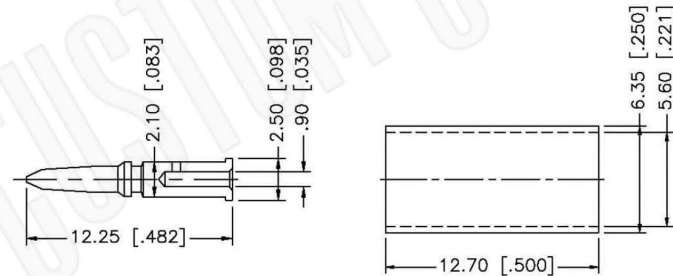
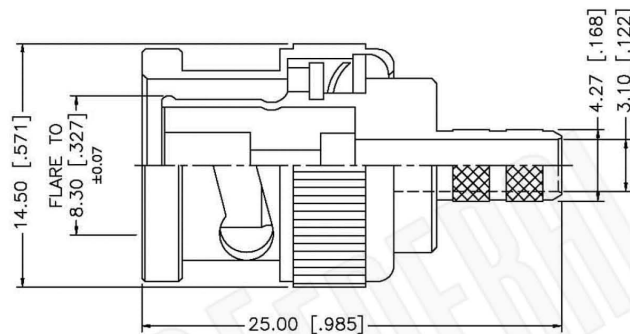
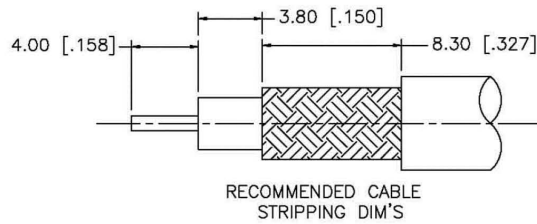

NOTE:

1. CRIMPED FERRULE
HEX CRIMP SIZE .213"
2. CRIMPED CONTACT PIN
HEX CRIMP SIZE .068"

Material Specifications

Cable(s): RG55,142,223,400
 Body: Brass
 Finish: Nickel
 Insulation: Teflon
 Impedence: 50 Ohms



Federal Custom Cable
www.FCCable.com
 1891 Alton Parkway, Irvine, CA 92606
 Phone: (949) 851-3114 | Fax: (949) 852-8136
Sales@FCCable.com

CAGE CODE 1UKX3 Dimensions Millimeters Inches Scale: N/A Revision:	Part Number: <h1>C1016</h1>	Description: <h2>BNC MALE CONNECTOR CRIMP FOR RG55, RG142, RG223, RG400 CABLES</h2>
	<p>NOTES:</p> <ol style="list-style-type: none"> 1. DIMENSIONS ARE IN MILLIMETERS INCHES 2. UNLESS OTHERWISE SPECIFIED ALL DIMENSIONS ARE NOMINAL 3. SPECIFICATIONS ARE SUBJECT TO CHANGE WITHOUT NOTICE 	<p>THIS DRAWING CONTAINS PROPRIETARY INFORMATION THAT BELONGS TO FEDERAL CUSTOM CABLE, LLC. ANY UNAUTHORIZED USE OF THIS DRAWING IS PROHIBITED WITHOUT WRITTEN PERMISSION FROM FEDERAL CUSTOM CABLE. ALL RIGHTS RESERVED. ©2016 COPYRIGHT FEDERAL CUSTOM CABLE, LLC.</p>

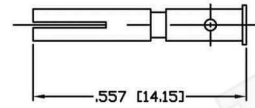
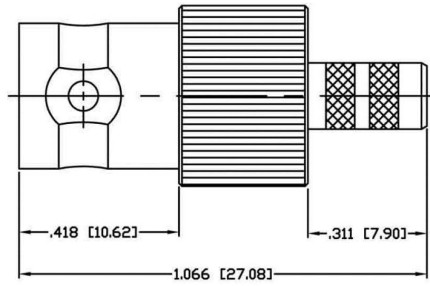

RECOMMENDED CRIMP DIE: .068"

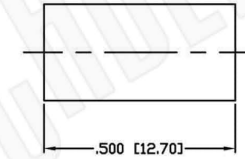

RECOMMENDED CRIMP DIE: .213"

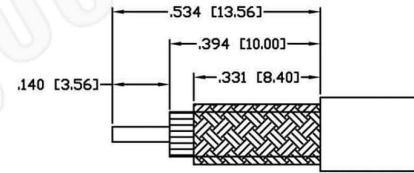

RECOMMENDED STRIPPING DIMENSIONS

Material Specifications

Cable(s): RG55-142-223-400
 Body: Brass
 Finish: Nickel
 Insulation: Teflon
 Impedence: 50 Ohms



Federal Custom Cable
www.FCCable.com

CAGE CODE
 1UKX3

Part Number:

Description:

C1003

**BNC FEMALE CONNECTOR CRIMP FOR RG55,
 RG142, RG223, RG400 CABLES**

1891 Alton Parkway, Irvine, CA 92606
 Phone: (949) 851-3114 | Fax: (949) 852-8136
Sales@FCCable.com

Dimensions
 Millimeters | Inches

Scale: N/A

Revision:

NOTES:
 1. DIMENSIONS ARE IN MILLIMETERS | INCHES
 2. UNLESS OTHERWISE SPECIFIED ALL DIMENSIONS ARE NOMINAL
 3. SPECIFICATIONS ARE SUBJECT TO CHANGE WITHOUT NOTICE

THIS DRAWING CONTAINS PROPRIETARY INFORMATION THAT BELONGS TO FEDERAL CUSTOM CABLE, LLC. ANY UNAUTHORIZED USE OF THIS DRAWING IS PROHIBITED WITHOUT WRITTEN PERMISSION FROM FEDERAL CUSTOM CABLE. ALL RIGHTS RESERVED. ©2016 COPYRIGHT FEDERAL CUSTOM CABLE, LLC.

RG223/U

50-Ohm Flexible Coax Cable; 0.210" Diameter, Double Shield, Black PVC Jacket



PART NUMBER:	RG223/U
CATAGORY:	FLEXIBLE
DESCRIPTION:	CABLE
IMPEDANCE:	50 OHMS
DIELECTRIC:	POLYETHYLENE
NOMINAL OUTSIDE DIAMETER:	0.212"
OUTSIDE DIAMETER:	0.116" DIAMETER
SPECIFICATIONS:	MIL-C-17D TYPE

PHYSICAL CHARACTERISTICS:

OUTER CONDUCTOR:	SILVER COATED COPPER DOUBLE BRAID
TYPE OF SHIELD:	99% COVERAGE
JACKET MATERIAL:	BLACK TYPE IIA NON-CONTAINING, NON-MIGRATING VINYL
INNER CONDUCTOR:	19 AWG SOLID SILVER PLATED COPPER, 8.8 OHM/1000FT NOMINAL DIRECT CURRENT RESISTANCE

ELECTRICAL CHARACTERISTICS:

NOMINAL CAPACITANCE (PICO FARAD/FT):	31.5
VELOCITY OF PROPAGATION:	66%
OPERATING TEMPERATURE (C):	-40 TO 80 DEGREES C
MAXIMUM OPERATING VOLTAGE:	1900 VOLTS
MAXIMUM ATTENUATION:	(dB/100ft)
A. 10 MHz:	1.35
B. 50 MHz:	3.00
C. 100 MHz:	4.30
D. 200 MHz:	6.00
E. 400 MHz:	8.80
F. 1000 MHz:	16.5
G. 3000 MHz:	36.0
APPROX WT/1000FT:	39 LBS.