

Material Specifications

Left Connector: C1013
 Right Connector: C1001
 Cable: RG316

NOTES:

1. XX EQUALS LENGTH IN INCHES
2. LF DESIGNATES LEAD FREE SOLDER

 Federal Custom Cable www.FCCable.com 1891 Alton Parkway, Irvine, CA 92606 Phone: (949) 851-3114 Fax: (949) 852-8136 Sales@FCCable.com	CAGE CODE 1UKX3	Part Number: CA1029LF-XX	Description: BNC MALE TO BNC FEMALE COAX CABLE ASSEMBLY WITH RG316 FLEXIBLE CABLE ROHS LEAD FREE
	Dimensions Millimeters Inches		
	Scale: N/A	NOTES: 1. DIMENSIONS ARE IN MILLIMETERS INCHES 2. UNLESS OTHERWISE SPECIFIED ALL DIMENSIONS ARE NOMINAL 3. SPECIFICATIONS ARE SUBJECT TO CHANGE WITHOUT NOTICE	THIS DRAWING CONTAINS PROPRIETARY INFORMATION THAT BELONGS TO FEDERAL CUSTOM CABLE, LLC. ANY UNAUTHORIZED USE OF THIS DRAWING IS PROHIBITED WITHOUT WRITTEN PERMISSION FROM FEDERAL CUSTOM CABLE. ALL RIGHTS RESERVED. ©2016 COPYRIGHT FEDERAL CUSTOM CABLE, LLC.
	Revision:		

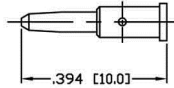
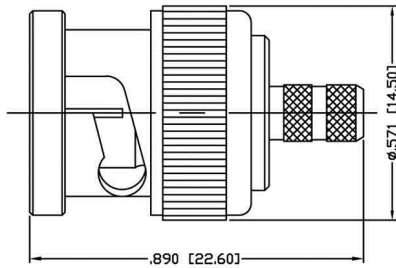

RECOMMENDED CRIMP DIE: .068"

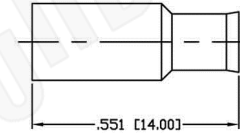
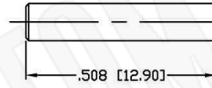

RECOMMENDED CRIMP DIE: .130" & .178"

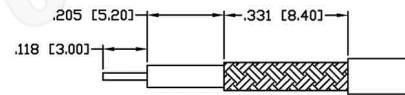

RECOMMENDED STRIPPING DIMENSIONS

Material Specifications

Cable(s): RG174-RG188-RG316
 Body: Brass
 Finish: Nickel
 Insulation: Teflon
 Impedence: 50 Ohms



FCC Federal Custom Cable
www.FCCable.com

CAGE CODE
 1UKX3

Part Number:

Description:

C1013

BNC MALE CONNECTOR CRIMP FOR RG174, RG188, RG316, B7805A CABLES

Dimensions
 Millimeters | Inches

Scale: N/A

Revision:

NOTES:
 1. DIMENSIONS ARE IN MILLIMETERS | INCHES
 2. UNLESS OTHERWISE SPECIFIED ALL DIMENSIONS ARE NOMINAL
 3. SPECIFICATIONS ARE SUBJECT TO CHANGE WITHOUT NOTICE

THIS DRAWING CONTAINS PROPRIETARY INFORMATION THAT BELONGS TO FEDERAL CUSTOM CABLE, LLC. ANY UNAUTHORIZED USE OF THIS DRAWING IS PROHIBITED WITHOUT WRITTEN PERMISSION FROM FEDERAL CUSTOM CABLE. ALL RIGHTS RESERVED. ©2016 COPYRIGHT FEDERAL CUSTOM CABLE, LLC.

1891 Alton Parkway, Irvine, CA 92606
 Phone: (949) 851-3114 | Fax: (949) 852-8136

Sales@FCCable.com

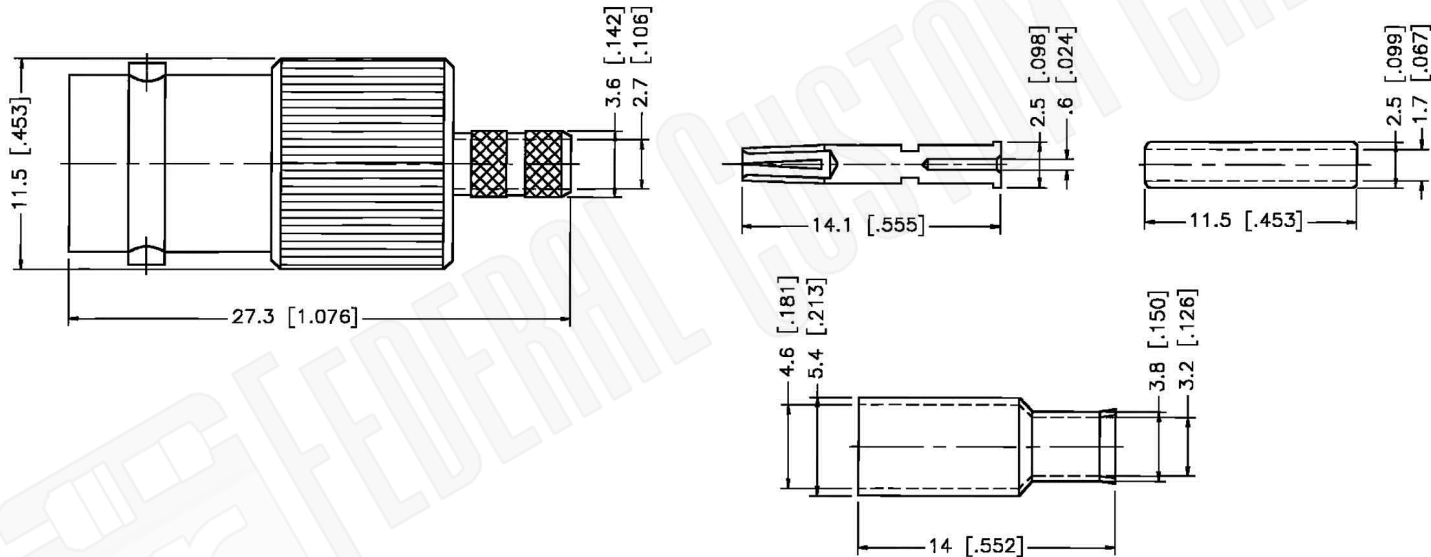
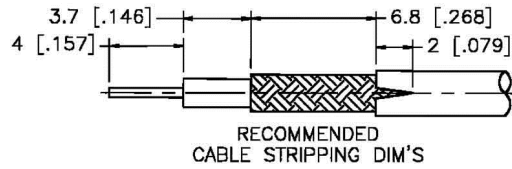

Material Specifications

Cable(s):	RG316, U-DOUBLE BRAIDED
Body:	Brass
Finish:	Nickel
Insulation:	Teflon
Impedence:	50 Ohms



Federal Custom Cable
www.FCCable.com

CAGE CODE
1UKX3

Part Number:

Description:

C1001

**BNC FEMALE CONNECTOR CRIMP FOR RG174,
RG188, RG316, B7805A CABLES**

1891 Alton Parkway, Irvine, CA 92606
Phone: (949) 851-3114 | Fax: (949) 852-8136
Sales@FCCable.com

Dimensions
Millimeters | Inches

Scale: N/A

Revision:

NOTES:
1. DIMENSIONS ARE IN MILLIMETERS | INCHES
2. UNLESS OTHERWISE SPECIFIED ALL DIMENSIONS ARE NOMINAL
3. SPECIFICATIONS ARE SUBJECT TO CHANGE WITHOUT NOTICE

THIS DRAWING CONTAINS PROPRIETARY INFORMATION THAT BELONGS TO FEDERAL CUSTOM CABLE, LLC. ANY UNAUTHORIZED USE OF THIS DRAWING IS PROHIBITED WITHOUT WRITTEN PERMISSION FROM FEDERAL CUSTOM CABLE. ALL RIGHTS RESERVED. ©2016 COPYRIGHT FEDERAL CUSTOM CABLE, LLC.

RG316/U

50-Ohm Flexible Coax Cable; 0.098" Diameter, Single Shield, Tan FEP Jacket



PART NUMBER:	RG316/U
CATAGORY:	FLEXIBLE
DESCRIPTION:	CABLE
IMPEDANCE:	50 OHMS +/-2
DIELECTRIC:	EXPANDED TEFLON
OVERALL DIAMETER:	0.098"
DIELECTRIC DIAMETER:	0.060"

PHYSICAL CHARACTERISTICS:

SHIELD:	SILVER PLATED COPPER
JACKET:	FLURINATED ETHYLENE PROPYLENE
OPERATING TEMPERATURE:	-55 C TO +200 C
WEIGHT:	12.2 LBS/1000FT
CENTER CONDUCTOR:	0.0201" DIAMETER (7/0.0067") SILVER COPPER CLAD STEEL

ELECTRICAL CHARACTERISTICS:

CAPACITANCE:	29.4 PFARAD/FT
MAX OPERATING VOLTAGE:	1200 VRMS
MAXIMUM ATTENUATION:	(db/100FT)
A. 100 MHz:	11.0
B. 400 MHz:	21.0
C. 1 GHz:	38.0
D. 3 GHz:	58.0
E. 5 GHz:	N/A
F. 10 GHz:	N/A
MAXIMUM FREQUENCY:	3.0
MAXIMUM POWER:	
A. 400 MHz:	240
B. 1 GHz:	160
C. 3 GHz:	80
D. 5 GHz:	57
E. 10 GHz:	30