

Material Specifications

Left Connector: C1016
 Right Connector: C1003
 Cable: RG400

NOTES:

1. XX EQUALS LENGTH IN INCHES

 Federal Custom Cable www.FCCable.com 1891 Alton Parkway, Irvine, CA 92606 Phone: (949) 851-3114 Fax: (949) 852-8136 Sales@FCCable.com	CAGE CODE 1UKX3	Part Number: CA1030-XX	Description: BNC MALE TO BNC FEMALE COAX CABLE ASSEMBLY WITH RG400 FLEXIBLE CABLE
	Dimensions Millimeters Inches		
	Scale: N/A	NOTES: 1. DIMENSIONS ARE IN MILLIMETERS INCHES 2. UNLESS OTHERWISE SPECIFIED ALL DIMENSIONS ARE NOMINAL 3. SPECIFICATIONS ARE SUBJECT TO CHANGE WITHOUT NOTICE	THIS DRAWING CONTAINS PROPRIETART INFORMATION THAT BELONGS TO FEDERAL CUSTOM CABLE, LLC. ANY UNAUTHORIZED USE OF THIS DRAWING IS PROHIBITED WITHOUT WRITTEN PERMISSION FROM FEDERAL CUSTOM CABLE. ALL RIGHTS RESERVED. ©2020 COPYRIGHT FEDERAL CUSTOM CABLE, LLC.
	Revision:		

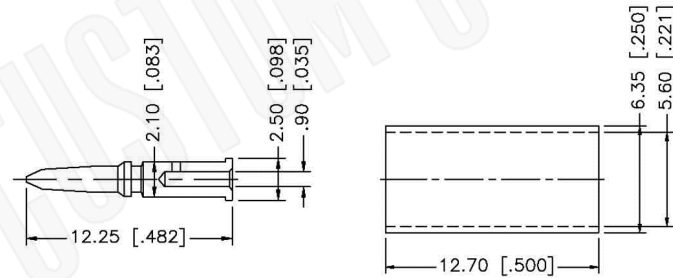
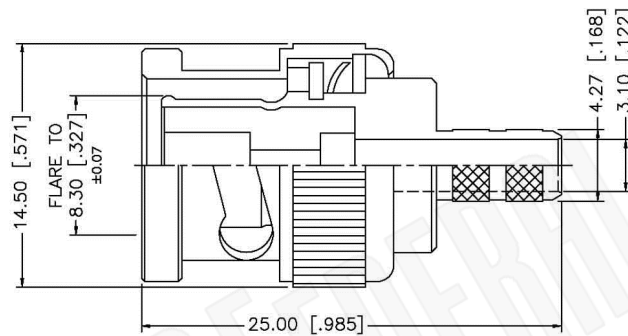
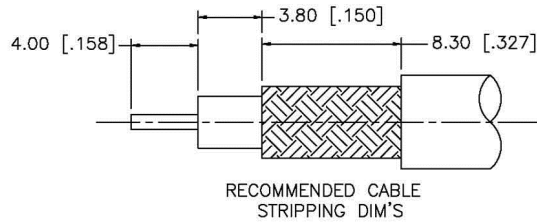

NOTE:

1. CRIMPED FERRULE
HEX CRIMP SIZE .213"
2. CRIMPED CONTACT PIN,
HEX CRIMP SIZE .068"

Material Specifications

Cable(s): RG55,142,223,400
 Body: Brass
 Finish: Nickel
 Insulation: Teflon
 Impedence: 50 Ohms



Federal Custom Cable
www.FCCable.com

CAGE CODE
1UKX3

Part Number:

Description:

C1016

BNC MALE CONNECTOR CRIMP FOR RG55, RG142, RG223, RG400 CABLES

Dimensions
Millimeters | Inches

Scale: N/A

Revision:

NOTES:
 1. DIMENSIONS ARE IN MILLIMETERS | INCHES
 2. UNLESS OTHERWISE SPECIFIED ALL DIMENSIONS ARE NOMINAL
 3. SPECIFICATIONS ARE SUBJECT TO CHANGE WITHOUT NOTICE

THIS DRAWING CONTAINS PROPRIETARY INFORMATION THAT BELONGS TO FEDERAL CUSTOM CABLE, LLC. ANY UNAUTHORIZED USE OF THIS DRAWING IS PROHIBITED WITHOUT WRITTEN PERMISSION FROM FEDERAL CUSTOM CABLE. ALL RIGHTS RESERVED. ©2016 COPYRIGHT FEDERAL CUSTOM CABLE, LLC.

1891 Alton Parkway, Irvine, CA 92606
 Phone: (949) 851-3114 | Fax: (949) 852-8136

Sales@FCCable.com

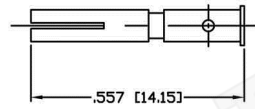
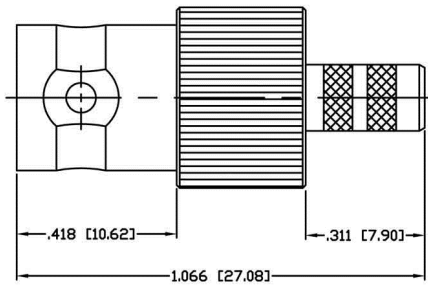

RECOMMENDED CRIMP DIE: .068"

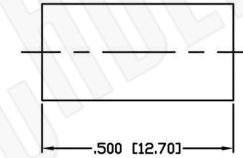

RECOMMENDED CRIMP DIE: .213"

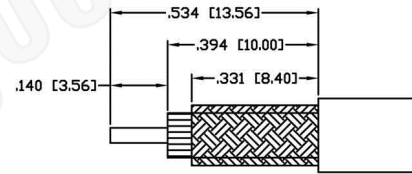

RECOMMENDED STRIPPING DIMENSIONS

Material Specifications

Cable(s): RG55-142-223-400
 Body: Brass
 Finish: Nickel
 Insulation: Teflon
 Impedence: 50 Ohms



Federal Custom Cable
www.FCCable.com
 1891 Alton Parkway, Irvine, CA 92606
 Phone: (949) 851-3114 | Fax: (949) 852-8136
Sales@FCCable.com

CAGE CODE 1UKX3
Dimensions Millimeters Inches
Scale: N/A
Revision:

Part Number:

C1003

Description:
BNC FEMALE CONNECTOR CRIMP FOR RG55, RG142, RG223, RG400 CABLES

NOTES:
 1. DIMENSIONS ARE IN MILLIMETERS | INCHES
 2. UNLESS OTHERWISE SPECIFIED ALL DIMENSIONS ARE NOMINAL
 3. SPECIFICATIONS ARE SUBJECT TO CHANGE WITHOUT NOTICE

THIS DRAWING CONTAINS PROPRIETARY INFORMATION THAT BELONGS TO FEDERAL CUSTOM CABLE, LLC. ANY UNAUTHORIZED USE OF THIS DRAWING IS PROHIBITED WITHOUT WRITTEN PERMISSION FROM FEDERAL CUSTOM CABLE. ALL RIGHTS RESERVED. ©2016 COPYRIGHT FEDERAL CUSTOM CABLE, LLC.

RG400/U

50-Ohm Flexible Coax Cable; 0.195" Diameter, Double Shield, Tan FEP Jacket

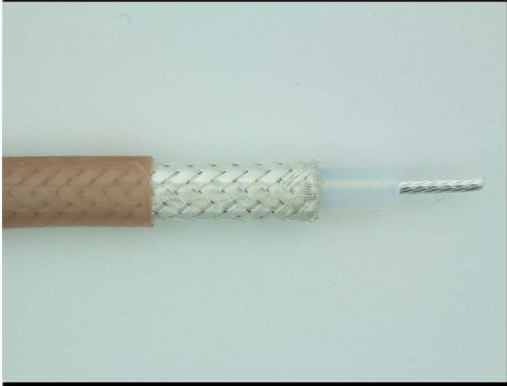

PART NUMBER:	RG400/U
CATAGORY:	FLEXIBLE
DESCRIPTION:	CABLE
IMPEDANCE:	50 OHMS +/-2
DIELECTRIC:	EXPANDED TEFLON
OVERALL DIAMETER:	0.195"
DIELECTRIC DIAMETER:	0.116"

PHYSICAL CHARACTERISTICS:

OPERATING TEMPERATURE RANGE:	-55 C TO +200 C
WEIGHT:	50 LBS/1000FT
CENTER CONDUCTOR:	0.0384" DIAMETER (19/0.008") SILVER PLATED COPPER
SHIELD:	DOUBLE BRAID SILVER PLATED COPPER
JACKET:	FLUORINATED ETHYLENE PROPYLENE

ELECTRICAL CHARACTERISTICS:

CAPACITANCE:	29.4 PFARAD/FT
MAX OPERATING VOLTAGE:	1900 VRMS
MAXIMUM ATTENUATION:	(db/100FT)
A. 100 MHz:	4.5
B. 400 MHz:	10.5
C. 1 GHz:	17.0
D. 3 GHz:	38.0
E. 5 GHz:	50.0
F. 10 GHz:	78.0
MAXIMUM FREQUENCY (GHz):	12.0
MAXIMUM POWER:	
A. 400 MHz:	1100
B. 1 GHz:	550
C. 3 GHz:	350
D. 5 GHz:	245
E. 10 GHz:	140