

Material Specifications

Left Connector: C1013
 Right Connector: C1127
 Cable: RG316

NOTES:

1. XX EQUALS LENGTH IN INCHES

FCC Federal Custom Cable
 www.FCCable.com
 1891 Alton Parkway, Irvine, CA 92606
 Phone: (949) 851-3114 | Fax: (949) 852-8136
 Sales@FCCable.com

CAGE CODE 1UKX3	Part Number: CA1116-XX	Description: BNC MALE TO SMA MALE COAX CABLE ASSEMBLY WITH RG316 FLEXIBLE CABLE
Scale: N/A	NOTES: 1. DIMENSIONS ARE IN MILLIMETERS INCHES 2. UNLESS OTHERWISE SPECIFIED ALL DIMENSIONS ARE NOMINAL 3. SPECIFICATIONS ARE SUBJECT TO CHANGE WITHOUT NOTICE	THIS DRAWING CONTAINS PROPRIETARY INFORMATION THAT BELONGS TO FEDERAL CUSTOM CABLE, LLC. ANY UNAUTHORIZED USE OF THIS DRAWING IS PROHIBITED WITHOUT WRITTEN PERMISSION FROM FEDERAL CUSTOM CABLE. ALL RIGHTS RESERVED. ©2020 COPYRIGHT FEDERAL CUSTOM CABLE, LLC.
Revision:		

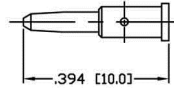
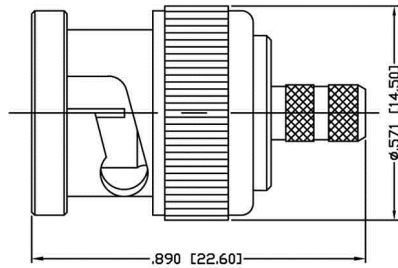

RECOMMENDED CRIMP DIE: .068"

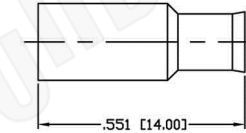
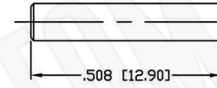

RECOMMENDED CRIMP DIE: .130" & .178"

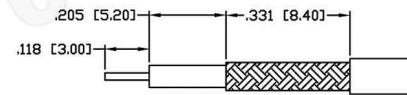

RECOMMENDED STRIPPING DIMENSIONS

Material Specifications

Cable(s): RG174-RG188-RG316
 Body: Brass
 Finish: Nickel
 Insulation: Teflon
 Impedence: 50 Ohms



Federal Custom Cable
www.FCCable.com

CAGE CODE
 1UKX3

Part Number:

Description:

C1013

BNC MALE CONNECTOR CRIMP FOR RG174, RG188, RG316, B7805A CABLES

Dimensions
 Millimeters | Inches

Scale: N/A

Revision:

NOTES:
 1. DIMENSIONS ARE IN MILLIMETERS | INCHES
 2. UNLESS OTHERWISE SPECIFIED ALL DIMENSIONS ARE NOMINAL
 3. SPECIFICATIONS ARE SUBJECT TO CHANGE WITHOUT NOTICE

THIS DRAWING CONTAINS PROPRIETARY INFORMATION THAT BELONGS TO FEDERAL CUSTOM CABLE, LLC. ANY UNAUTHORIZED USE OF THIS DRAWING IS PROHIBITED WITHOUT WRITTEN PERMISSION FROM FEDERAL CUSTOM CABLE. ALL RIGHTS RESERVED. ©2016 COPYRIGHT FEDERAL CUSTOM CABLE, LLC.

1891 Alton Parkway, Irvine, CA 92606
 Phone: (949) 851-3114 | Fax: (949) 852-8136

Sales@FCCable.com

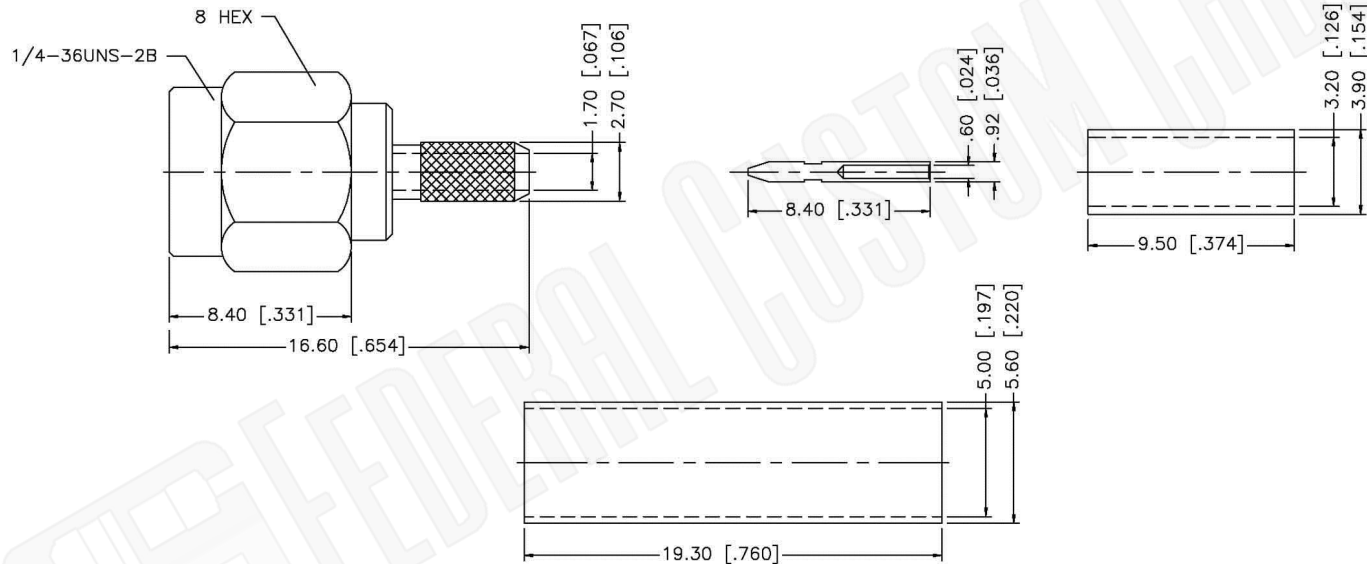
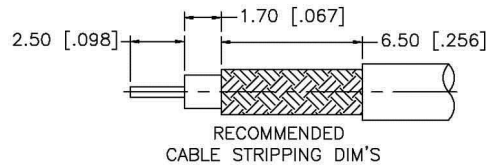

NOTE:
1. CRIMPED FERRULE
HEX CRIMP SIZE .128"



Material Specifications

Cable(s): RG174, 188A, 316, B7805A
 Body: Brass
 Finish: Gold
 Insulation: Teflon
 Impedence: 50 Ohms

Federal Custom Cable
www.FCCable.com
 1891 Alton Parkway, Irvine, CA 92606
 Phone: (949) 851-3114 | Fax: (949) 852-8136
Sales@FCCable.com

CAGE CODE 1UKX3 Dimensions Millimeters Inches Scale: N/A Revision:	Part Number: <h1>C1127</h1>	Description: <h2>SMA MALE CONNECTOR CRIMP FOR RG174, RG188, RG316, B7805A CABLES</h2>
	NOTES: 1. DIMENSIONS ARE IN MILLIMETERS INCHES 2. UNLESS OTHERWISE SPECIFIED ALL DIMENSIONS ARE NOMINAL 3. SPECIFICATIONS ARE SUBJECT TO CHANGE WITHOUT NOTICE	THIS DRAWING CONTAINS PROPRIETARY INFORMATION THAT BELONGS TO FEDERAL CUSTOM CABLE, LLC. ANY UNAUTHORIZED USE OF THIS DRAWING IS PROHIBITED WITHOUT WRITTEN PERMISSION FROM FEDERAL CUSTOM CABLE. ALL RIGHTS RESERVED. ©2016 COPYRIGHT FEDERAL CUSTOM CABLE, LLC.

RG316/U

50-Ohm Flexible Coax Cable; 0.098" Diameter, Single Shield, Tan FEP Jacket



PART NUMBER:	RG316/U
CATAGORY:	FLEXIBLE
DESCRIPTION:	CABLE
IMPEDANCE:	50 OHMS +/-2
DIELECTRIC:	EXPANDED TEFLON
OVERALL DIAMETER:	0.098"
DIELECTRIC DIAMETER:	0.060"

PHYSICAL CHARACTERISTICS:

SHIELD:	SILVER PLATED COPPER
JACKET:	FLURINATED ETHYLENE PROPYLENE
OPERATING TEMPERATURE:	-55 C TO +200 C
WEIGHT:	12.2 LBS/1000FT
CENTER CONDUCTOR:	0.0201" DIAMETER (7/0.0067") SILVER COPPER CLAD STEEL

ELECTRICAL CHARACTERISTICS:

CAPACITANCE:	29.4 PFARAD/FT
MAX OPERATING VOLTAGE:	1200 VRMS
MAXIMUM ATTENUATION:	(db/100FT)
A. 100 MHz:	11.0
B. 400 MHz:	21.0
C. 1 GHz:	38.0
D. 3 GHz:	58.0
E. 5 GHz:	N/A
F. 10 GHz:	N/A
MAXIMUM FREQUENCY:	3.0
MAXIMUM POWER:	
A. 400 MHz:	240
B. 1 GHz:	160
C. 3 GHz:	80
D. 5 GHz:	57
E. 10 GHz:	30