

**Material Specifications**

Left Connector: C1013  
 Right Connector: C1144  
 Cable: RG188

**NOTES:**

1. XX EQUALS LENGTH IN INCHES

 <b>Federal Custom Cable</b> www.FCCable.com  1891 Alton Parkway, Irvine, CA 92606 Phone: (949) 851-3114   Fax: (949) 852-8136 Sales@FCCable.com	<b>CAGE CODE</b> 1UKX3	<b>Part Number:</b> CA1596-XX	<b>Description:</b> BNC MALE TO SMA MALE RIGHT ANGLE COAX CABLE ASSEMBLY WITH RG188 FLEXIBLE CABLE
	<b>Dimensions</b> Millimeters   Inches		
	<b>Scale:</b> N/A	<b>NOTES:</b> 1. DIMENSIONS ARE IN MILLIMETERS   INCHES 2. UNLESS OTHERWISE SPECIFIED ALL DIMENSIONS ARE NOMINAL 3. SPECIFICATIONS ARE SUBJECT TO CHANGE WITHOUT NOTICE	THIS DRAWING CONTAINS PROPRIETART INFORMATION THAT BELONGS TO FEDERAL CUSTOM CABLE, LLC. ANY UNAUTHORIZED USE OF THIS DRAWING IS PROHIBITED WITHOUT WRITTEN PERMISSION FROM FEDERAL CUSTOM CABLE. ALL RIGHTS RESERVED. ©2020 COPYRIGHT FEDERAL CUSTOM CABLE, LLC.
	<b>Revision:</b>		

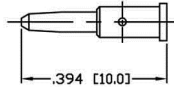
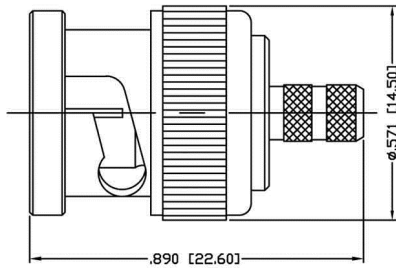

RECOMMENDED CRIMP DIE: .068"

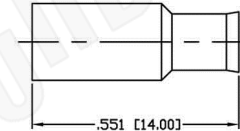
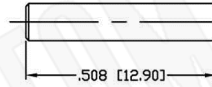

RECOMMENDED CRIMP DIE: .130" & .178"

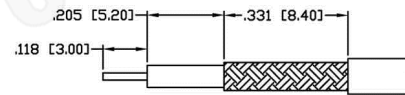

RECOMMENDED STRIPPING DIMENSIONS

### Material Specifications

Cable(s): RG174-RG188-RG316  
 Body: Brass  
 Finish: Nickel  
 Insulation: Teflon  
 Impedence: 50 Ohms



**Federal Custom Cable**  
[www.FCCable.com](http://www.FCCable.com)

CAGE CODE  
1UKX3

Part Number:

Description:

**C1013**

**BNC MALE CONNECTOR CRIMP FOR RG174, RG188, RG316, B7805A CABLES**

1891 Alton Parkway, Irvine, CA 92606  
 Phone: (949) 851-3114 | Fax: (949) 852-8136

Dimensions  
Millimeters | Inches

Scale: N/A

Revision:

NOTES:  
 1. DIMENSIONS ARE IN MILLIMETERS | INCHES  
 2. UNLESS OTHERWISE SPECIFIED ALL DIMENSIONS ARE NOMINAL  
 3. SPECIFICATIONS ARE SUBJECT TO CHANGE WITHOUT NOTICE

THIS DRAWING CONTAINS PROPRIETARY INFORMATION THAT BELONGS TO FEDERAL CUSTOM CABLE, LLC. ANY UNAUTHORIZED USE OF THIS DRAWING IS PROHIBITED WITHOUT WRITTEN PERMISSION FROM FEDERAL CUSTOM CABLE. ALL RIGHTS RESERVED. ©2016 COPYRIGHT FEDERAL CUSTOM CABLE, LLC.

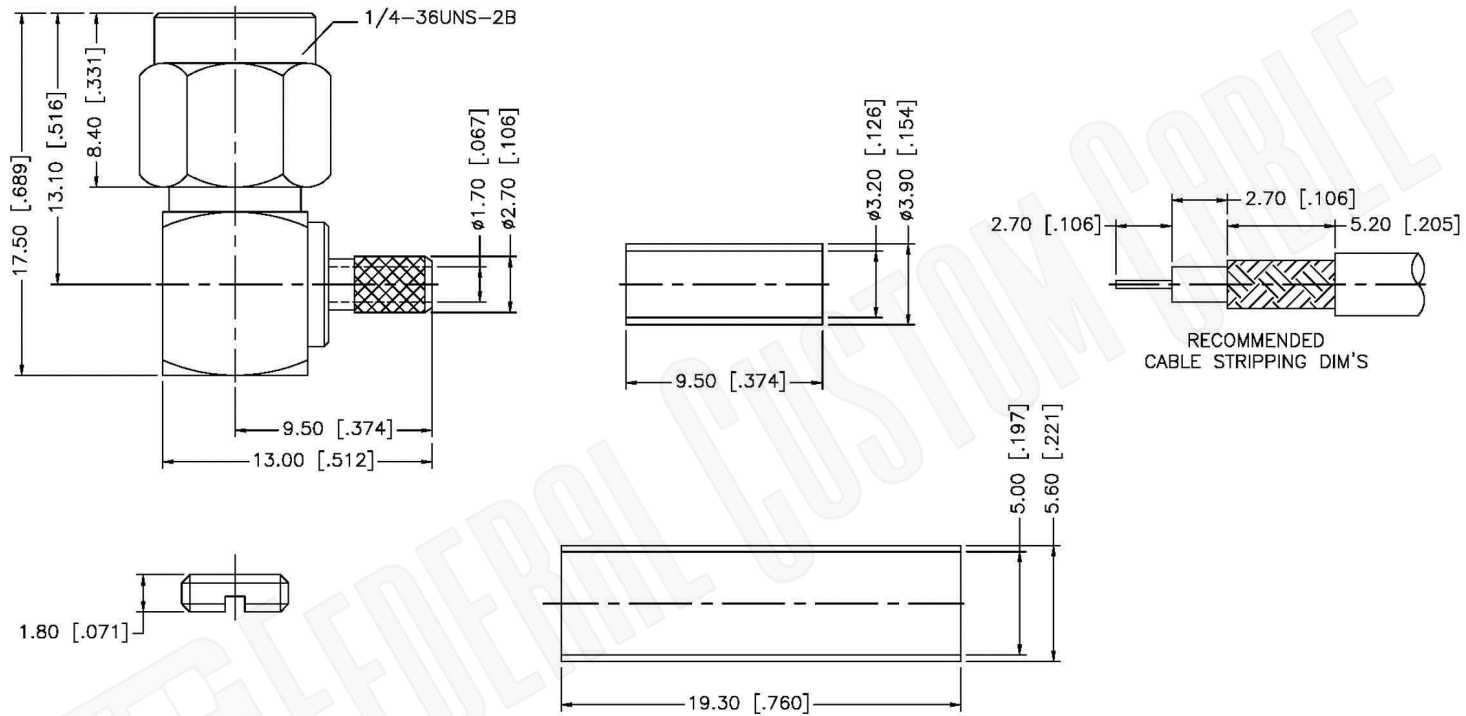

NOTES:  
1. CRIMPED FERRULE HEX CRIMP SIZE .128"



### Material Specifications

Cable(s): RG174, 188A, 316, B7805A  
 Body: Brass  
 Finish: Gold  
 Insulation: Teflon  
 Impedence: 50 Ohms

**Federal Custom Cable**  
[www.FCCable.com](http://www.FCCable.com)  
 1891 Alton Parkway, Irvine, CA 92606  
 Phone: (949) 851-3114 | Fax: (949) 852-8136  
[Sales@FCCable.com](mailto:Sales@FCCable.com)

<b>CAGE CODE</b> 1UKX3  <b>Dimensions</b> Millimeters   Inches  <b>Scale:</b> N/A  <b>Revision:</b>	<b>Part Number:</b>  <h1>C1144</h1>	<b>Description:</b>  <h2>SMA MALE CONNECTOR RIGHT ANGLE CRIMP FOR RG174, RG188, RG316, B7805A CABLES</h2>
	<b>NOTES:</b> 1. DIMENSIONS ARE IN MILLIMETERS   INCHES 2. UNLESS OTHERWISE SPECIFIED ALL DIMENSIONS ARE NOMINAL 3. SPECIFICATIONS ARE SUBJECT TO CHANGE WITHOUT NOTICE	THIS DRAWING CONTAINS PROPRIETARY INFORMATION THAT BELONGS TO FEDERAL CUSTOM CABLE, LLC. ANY UNAUTHORIZED USE OF THIS DRAWING IS PROHIBITED WITHOUT WRITTEN PERMISSION FROM FEDERAL CUSTOM CABLE. ALL RIGHTS RESERVED. ©2016 COPYRIGHT FEDERAL CUSTOM CABLE, LLC.

# RG188A/U

## 50-Ohm Flexible Coax Cable; 0.110" Diameter, Single Shield, White PTFE Jacket



PART NUMBER:	<b>RG188A/U</b>
CATAGORY:	FLEXIBLE
DESCRIPTION:	CABLE
IMPEDANCE:	50 OHMS +/-2
DIELECTRIC:	EXPANDED TEFLON
OVERALL DIAMETER:	0.100"
DIELECTRIC DIAMETER:	0.060"

### PHYSICAL CHARACTERISTICS:

SHIELD:	SILVER PLATED COPPER
JACKET:	TEFLON
OPERATING TEMPERATURE:	-55 C TO +250 C
WEIGHT:	12.0 LBS/1000FT
CENTER CONDUCTOR:	0.0201" DIAMETER (7/0.0067") SILVER COPPER CLAD STEEL

### ELECTRICAL CHARACTERISTICS:

CAPACITANCE:	29.4 PFARAD/FT
MAXIMUM OPERATING VOLTAGE:	1200 VRMS
MAXIMUM ATTENUATION:	(dB/100FT)
A. 100 MHz:	11.0
B. 400 MHz:	21.0
C. 1 GHz:	38.0
D. 3 GHz:	58.0
MAXIMUM FREQUENCY (GHz):	3.0
MAXIMUM POWER:	
A. 400 MHz:	240
B. 1 GHz:	160
C. 3 GHz:	80
D. 5 GHz:	57
E. 10 GHz:	30